

FCR MICROJET RECORDER (100mm)

DATA SHEET

PHC

This recorder can record a maximum of 6 channels of DC voltage, mA, thermocouples and resistance bulbs.

The adoption of an ink jet system makes it possible to record measured data in analog trace mode or to print in digital mode at a high speed. This 100mm-wide recorder performs recording clearly in 6 different colors.

FEATURES

1. Compact size

Compact and lightweight design, 199mm in depth and about 2.1kg in mass{weight}.

2. High quality recording

- Ink jet system is used for recording and printing measured data in 6 different colors at a high speed. Operating noise is minimized.
- Six continuous traces without pen offset are possible with this compact size of recorder; a unique recording system is used for the first time in the industry.
- Scale of each channel is printed on chart paper, eliminating the need for scales.

3. Easy setting of input signals

DC voltage input (5mV span, 50V max.), 12 kinds of thermocouples (Type B, R, S, K, E, J, T, N, W, L, U, PN) and resistance bulbs (Pt100) can be set for each channel.

4. Digital printing

Beside the analog recording of measured data, digital printing is also available (periodic printing, list printing, alarm printing, daily report printing, message printing).

- Periodic data printing: Channel No., date, time, unit, chart speed, measured value
- List printing: Date, time, unit, recording range, scaling value, alarm set value, chart speed, Tag No.
- Alarm printing: Channel No., alarm type, on/off time, output relay No.
- Daily report and totalized data printing: Printing of maximum, minimum, average and total of data measured during maximum 24 hours
- Message printing : 10 messages, 16-character user-entered messages

5. Interactive key operation

Fluorescent indicator is used to clearly indicate alphanumeric characters and symbols.

Input mode, recording range, alarm value, chart speed, etc., can be set according to the comments indicated by the display and operating keys. No bothersome operation is required.



6. Easy handling

- A cartridge type recording device is used for easy replacement.
- Allow to draw out the chart paper while recording.
- Shortage of ink is detected in early stages and an alarm is given to the operator.
- The end of chart paper is detected and indicated on the front panel display.
- Shortage of ink and the end of chart paper alarm output is possible.

7. Full variety of functions

- Alarm relay output/external control (record start/stop, chart speed change, data printing, message printing). This unit can easily be connected to the recorder by user (option).
- Chart paper illumination lamp (option): The result of printing can be checked even in lower light.
- Burnout function is provided as a standard.
- Various recording: Enlarged/reduced recording, auto-range recording, zone recording.
- Calculation: Square root extraction, subtraction, engineering unit conversion, logarithm.
- Language: Selectable 3 languages in display and printing.
- Passcode security is configurable.
- Transmission function: RS-485 (option)
- The message print and alarm print function are operational, even when the recording mode is off.
- All parameters of recording format, daily report, totalize, message and periodic data printing can be printed out.

SPECIFICATIONS

Input system

Input points: 3 or 6 continuous recording
6 intermittent recording

Input signal: Thermocouple input...B, R, S, K, E, J, T, N, W, L, U, PN
Resistance bulb input...Pt100Ω
DC voltage input...50mV, 500mV, 5V, 50V range
DC current input...4 to 20mA DC, 10 to 50mA DC
(Shunt resistor (option) need to be connected to the terminal)

Max. input voltage:

- Thermocouple, resistance bulb and DC voltage (50mV, 500mV range) ...±10VDC or less
- DC voltage input (5V, 50V range) ...±100VDC or less

Input signal setting and change:

Setting and change of input signal between thermocouple, resistance bulb and DC voltage (50mV, 500mV, 5V, 50V range) is possible for each channel by the setting pin in the instrument.

Setting of recording range:

Setting is possible within the reference range by using the keyboard.

Burnout function: When thermocouple or resistance bulb input is disconnected, the recording is deflected to 100%.

Reference range:

Kind		Reference range	Reference range
Thermocouple	B	400 to 1760°C	752 to 3200°F
	R	0 to 1760°C	32 to 3200°F
	S	0 to 1760°C	32 to 3200°F
	K	-200 to 1370°C	-328 to 2498°F
	E	-200 to 800°C	-328 to 1472°F
	J	-200 to 1100°C	-328 to 2012°F
	T	-200 to 400°C	-328 to 752°F
	N	0 to 1300°C	32 to 2372°F
	W	0 to 1760°C	32 to 3200°F
	L	-200 to 900°C	-328 to 1652°F
	U	-200 to 400°C	-328 to 752°F
PN	0 to 1300°C	32 to 2372°F	
Resistance bulb	Pt100	-200 to 600°C	-328 to 1112°F
DC voltage		-50 to +50mV	Scaling is possible within the range of -32767 to +32767 (decimal point may be put as necessary)
		-500 to +500mV	
		-5 to +5V	
		-50 to +50V	

Note: N : NICROSIL-NISIL (IEC584)
W : +side 5% Re, -side 26% ReW (Hoskins Mfg. Co., U.S.A.)
L : +side Fe, -side Cu.Ni alloy (DIN43710)
U : +side Cu, -side Cu.Ni alloy (DIN43710)
PN : Platinel
Pt100 : DIN IEC751

Recording system

Writing system: Ink jet system, 6 colors

Chart width: 100mm

Recording color: No. 1 channel (orange), No. 2 channel (green), No. 3 channel (purple), No. 4 channel (red), No. 5 channel (black), No. 6 channel (blue)
Recording color can be assigned for each channel.

Chart length: Z fold 15.08m

Chart speeds: Continuous recording type
5 to 400 mm/h, continuous recording
401 to 1500 mm/h, intermittent recording
Intermittent recording type
5 to 1500 mm/h
Each can be set in 1 mm/h steps.

Recording cycle: Intermittent recording...30 sec/all points
Continuous recording...Depends on chart speed.
<Calculation formula>
Recording cycle [sec] = $\frac{400}{\text{Chart speed [mm/h]}}$
(not faster than 2 seconds.)

Measuring cycle: Up to 3 inputs...160ms
More than 3 inputs...320ms

Service life of ink: (Depends on operating conditions)
About 6 months for 6 points of linear recording at 20 mm/h of chart speed

Chart handling: Tear off without disturbance of recording.

Indicating system

Indication: Fluorescent indication (blue-green),
20 characters x 2 lines

Characters indicated:
5 x 7 dots, 4.16mm high, 2.25mm wide

Contents of indication:

- (1) Measured value:
Temperature...1 digit below decimal point;
Voltage...6 digits (including sign and decimal point)
Measured value of No.1 channel to No.6 can be indicated simultaneously.
- (2) Channel No.: 1 digit (1 to 6)
- (3) Engineering unit: Max. 7 digits (°C, °F, %, Pa, bar, ppm, m³/h, etc.)
- (4) Tag No....8 characters
- (5) Time: Year, month, day, hour, minute
- (6) Status indication: Record ON, chart end, battery alarm, alarm, ink shortage alarm, burnout, carriage failure

Configuration: These can be set according to the comments indicated by operating keys as follows,
Passcode
Main chart speed
Sub chart speed
Alarm setting
Record mode (trend/logging)
Recording range
Input signal
List print request
Tag No.
Daily report setting
Totalize function
Communication parameter
Date and time setting
Ink monitor clear
Illumination on/off
Message definition
Measured value shift

Printing system

Writing system: Ink jet system, 6 colors

Periodic data printing:

Measured value, unit, date, time, time line, chart speed, channel No.

List printing:

- (1) Measured value list (date, time, channel No., measured value, unit)
- (2) Parameter list (date, time, channel No., recording range, scaling, unit, alarm set value, chart speed, Tag No.)
- (3) Test pattern (all characters and color patterns)

Message printing: 10 messages, 16-character user-entered messages

Alarm printing: Channel No., alarm type (H, L, RH, RL), output relay No., on/off time

Burnout printing: Burnout channel No. and time

Other: Ink shortage message, automatic range selection mark, recording start mark, chart speed change mark

Note: Printing is not available for more than 401 mm/h (continuous recording), or more than 51 mm/h (intermittent recording).

Performance and characteristics

Accuracy and resolution:

Performance under reference condition (23±2°C, 65±10%RH, power voltage and frequency variation ±1%, warm-up time 30 minutes or more, vertical mounting, free from the effect of external noise)

Input		Indication (digital)		Recording	
		Accuracy	Resolution	Accuracy	Resolution
Thermocouple	B	±(0.15% +1 digit) (without reference junction compensation error)	0.1°C	Indication accuracy, ±0.25% of recording span	0.1mm minimum
	R				
	S				
	K				
	E				
	J				
	T				
	N				
	W				
	L				
	U				
PN					
Resistance bulb	Pt100	±(0.15% +1 digit)	0.1°C		
DC voltage	-50 to +50mV	±(0.15% +1 digit)	10µV		
	-500 to +500mV				
	-5 to 5V				
	-50 to 50V				

Note: Indication accuracy is in % of reference range.
 Indication accuracy of B type TC is ±0.25% between 400°C to 600°C.
 Indication accuracy of all type TC is ±0.25% + 1digit between -200°C to -100°C.

Input resistance: Thermocouple: >10MΩ
 50mV range: >10MΩ
 500mV range: >100kΩ
 5V and 50V range: >1MΩ

Chart speed accuracy: ±0.1% (expansion and contraction of paper is not included)

Clock accuracy: ±50ppm or less (monthly error; about 2 minutes)

Isolation: 100MΩ (between each terminal and earth, at 500V DC)
 Channel to channel...500V AC, 1 min
 Power channel to ground...2000V AC, 1 min
 Input channel to ground.... 500V AC, 1 min
 (leakage current: 5mA or less)

Reference junction compensation accuracy:

K, E, J, T, N, L, U, PN ±0.5°C
 R, S, B, W..... ±1°C

Common mode noise rejection:

120dB at 50, 60Hz ±0.1Hz

Series mode noise rejection:

30dB at 50, 60Hz ±0.1Hz

Physical data

Mounting: Panel (may be inclined up to 30° backwards from the vertical.)

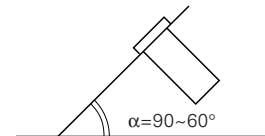

Two more recorders can be mounted side by side.

Material: Case...Steel plate
 Front door frame...Polycarbonate with glass wool

Mass(weight): Approx. 2.1 kg (without option)
 Approx. 2.2 kg (with option)

Case size: Bezel 144x144mm
 Depth 199mm
 Cutout 137x137mm

Finish color: Case...Black, Front door frame...Black
External terminals:Screw terminal (M4 screw)

Power requirement

Linesupply: Rated voltage
 100 to 120V AC or 200 to 240V AC
 Usable range
 85 to 150V AC or 150 to 300V AC

Frequency: 50/60Hz
Power consumption: About 20VA, 100V AC, without option
 About 26VA, 100V AC, with option

Operating environment

(for devices to operate continuously)

Temperature limits: 0 to 50°C
Humidity limits: 20 to 80%RH, non condensing is required (temperature x humidity<3200)

Vibration: 10 to 60Hz, 0.2m/s²{0.02G} or less

Mounting position: Front inclination 0°, rear inclination 30°, left/right inclination 0°

Signal source resistance: Thermocouple input...1kΩ or less
 Voltage input...Less than 0.1% of input resistance
 Resistance bulb input...Less than 10Ω per line (Resistance of each wire of 3-wire system should be balanced with others.)

Warm-up time: 30 min or more

Shock: No external shock

Environmental protection: IEC IP50 (front door)

Operating environment influence

Power supply variation influence:

Voltage variation: 85 to 150VAC or 150 to 300VAC

Change in indication... $\pm(0.1\%+1$ digit) max.

Change in recording... $\pm 0.2\%$ of recording span, max.

Frequency variation: 47 to 63Hz

Change in indication... $\pm(0.1\%+1$ digit) max.

Change in recording... $\pm 0.2\%$ of recording span, max.

Input signal source resistance or wiring resistance influence:

Thermocouple... 10 μ V per 100 Ω

Voltage input...Variation of 0.1% change of resistance

Change in indication... $\pm(0.1\%+1$ digit) max.

Change in recording... $\pm 0.2\%$ of recording span, max.

Resistance bulb...Variation of resistance with changes in 10 Ω per wire

Change in indication... $\pm(0.1\%+1$ digit) max.

Change in recording... $\pm 0.2\%$ of recording span, max.

(3 wires should be balanced.)

Temperature influence:

Change in indication... $\pm 0.2\%$ of reading/10 $^{\circ}$ C, max.

Change in recording... $\pm 0.5\%/10^{\circ}$ C, max.

Reference junction compensation... $\pm 0.27^{\circ}$ C/10 $^{\circ}$ C, max.

Mounting position influence:

Inclination within 30 $^{\circ}$

Change in indication... $\pm(0.1\%+1$ digit) max.

Change in recording... $\pm 0.2\%$ of recording span, max.

Vibration influence:

Linear vibration with 10 to 60Hz of frequency and 0.2m/s 2 {0.02G} of acceleration is applied to each of 3 directions for 2 hours.

Change in indication... $\pm(0.1\%+1$ digit) max.

Change in recording... $\pm 0.2\%$ of recording span, max.

Chart paper influence:

Standard temperature/humidity: 20 $^{\circ}$ C, 65%RH

Expansion at 85%RH... 0.4% max.

Contraction at 35%RH... 0.5% max.

Alarm

Setting method: Setting from keyboard

Number of alarm levels:

Max. 4 levels for each channel

Alarm types:

High(H), Low(L), High-rate of change(RH), Low-rate of change(RL)

Alarm action indication:

Kind of alarm and output relay No. are indicated for each channel at occurrence of alarm.

Printing:

Channel No., kind of alarm, output relay No. and on/off time are printed on chart paper.

Output:

See optional specifications.

Hysteresis:

Approx. 0.5% of recording span

Alarm timing:

Recognition; 1 second (worst case) Action; additional 1 second (worst case)

Alarm latch:

Hold the alarm display and alarm output.

Others:

Shortage of ink and the end of chart paper alarm output is possible.

Transportation/storage condition

Temperature limits:

-10 to +60 $^{\circ}$ C

Humidity limits:

5 to 90%RH, non condensing is required

Vibration:

10 to 60Hz, 2.45m/s 2 {0.25G}

Shock:

294m/s 2 {30G} or less

Optional specifications

1. Chart illumination:

Cold cathode fluorescent

2. Alarm output/3-point external control:

This unit can be mounted from the rear side of the recorder.

(1) Alarm output (DO):

6 points of relay contact N.O. (1a) or N.C. (1b) output for individual channel operation or common operation

Contact capacity:

N.O. contact 240V AC/3A
30V DC/3A

N.C. contact 125V AC/0.4A
30V DC/2A

(2) External control (DI):

The following control is possible with external contact signal.

- Recording start/stop; Recording start/stop is effected by contact signal. Recording is started when contact is closed and stopped when contact is open.
- Chart speed change; Selection between normal and remote chart speeds is effected by contact signal. Remote chart speed is selected when contact is closed and normal when contact is open.
- Measured value printing; Measured value list printing (date, time, channel No., measured value, unit) is effected by contact signal. Printing is started when contact is closed.
- Message printing

Note: For external control, use a dry contact. Contact capacity: 12V DC, 0.05A, N.O. (1a) contact

3. Transmission function:

RS-485 interface for transmitting measured value and receiving the condition of setting.

Transmission method	Half-duplex bit serial
Synchronizing method	Start-stop synchronizing
Code	Binary Data length, 8 bits Parity: odd/even/none Stop bit: 1 or 2
Transmission speed	2400, 4800, 9600, 19200 bps
Number of units connected	Max. 31 units
Transmission distance	Max. 1 km

Remarks: When connecting through RS-232C, be sure to use a 232 to 485 converter.
The following shows a recommended converter.
Maker: System Sakom Co., Ltd., Japan
Tel: +81-3-3797-0211
Type: KS-485

Periodic data printing function	Time, date, chart speed, measured value and unit can be printed at fixed intervals. Printing can be enabled/disabled from keyboard.
Message printing	Maximum 10 messages, 16-character user-entered messages can be printed.
Alarm printing function	Time, channel No., kind of alarm, and output relay No. can be printed when alarm is on or off.
Unit indication	Engineering units such as °C, °F, %, mV, mA, Pa, l, etc., are indicated (setting from key board).
Scaling function	Scaling with DC voltage input is possible. (Setting of decimal point is also possible within the range of -32767 to +32767).
Subtract function	Difference between any channels is recorded (channel is set from keyboard).
Logarithm	Measured value can be displayed and printed by 10 ⁿ power.
Auto-range recording	Recording range is automatically changed for recording in the event of overrange or underrange (setting with keyboard). This function is not available for combination of zone recording and enlarged/reduced recording.
Zone recording	Recording area is divided into a maximum of 3 zones for recording. This function is not available for combination of automatic range selection and enlarged/reduced recording.
Enlarged/reduced recording	A part of recording area of each channel is expanded or contracted for recording. This function is not available for combination of automatic range selection and zone recording.
Square-root extraction function	Square-root extraction of DC voltage input is possible.
Daily report function	Measured value of every hour for maximum one day (24 data) in each channel is stored for printing. Maximum, minimum and average values are also printed at the same time. ON-OFF operation, ON-OFF of each channel and operation start time/stop time can be set from keyboard.
Totalize function	Integrated value of every hour for maximum one day (24 data) in each channel is stored for printing (integration in 1 sec steps). Possible to print total value only. Total value is also printed at the same time. ON-OFF operation, ON-OFF of each channel and operation start time/stop time can be set from keyboard.
Measured value shift	Shift the zero point and inclination of the measured value so that the measured value can be adjusted according to other instruments.
Memory backup	Set data and clock function are protected by built-in lithium battery (expected battery life, about 10 years under normal temperature).
Input filter	Response is delayed according to sudden changes in input of each channel (1st order lag filter). Time constant setting range: 0 to 900 sec (setting from keyboard).
Burnout function	When thermocouple or resistance bulb input is disconnected, it is deflected 100%. Also, it is indicated and printed at the same time.
Passcode	4 digits passcode security is available.
Language	English, German, or French is selectable for display and printing.
Alarm latch function	The alarm display and alarm output are held even after the cause of alarming was gone. ON-OFF operation can be set from keyboard. Cancellation of the held alarm can be made from external control (DI).
Parameter copy	Set parameters on any channel can be copied to any other channels.

FUNCTIONS

Function	Description	
Range setting	Recording range can be set for each channel.	
Input setting	Any input can be set for each channel.	
Skip function	Used to skip recording, indication and alarm at any measuring point.	
List printing function	Measured value list	Date, time, and measured value unit can be printed.
	Parameter list	Date, time, recording range, scaling, unit, kind of input, alarm set value, chart speed, and Tag No. can be printed.
	Test pattern	All characters and color patterns can be printed.

CODE SYMBOLS

1	2	3	4	5	6	7	8	-	9	10	11	12	13
P	H	C		0	0	3		-				V	
Description													
Recording points													
3 3 3 continuous recording													
6 6 6 continuous recording													
7 6 6 intermittent recording													
Power Supply													
A 100 to 120V AC 50/60Hz													
E 200 to 240V AC 50/60Hz													
Chart paper illumination													
A Without													
B With													
Alarm output/external control													
0 Without													
1 6-point alarm output (N.O.)/ 3-point external control													
2 6-point alarm output (N.C.)/ 3-point external control													
Transmission function													
Y Without													
R With RS-485													

Remarks: Input signal
Setting prior to delivery is as follows.
• Thermocouple K: 0 to 1200°C

Note: Contact Fuji Electric for additional features not listed such as Flow integration record and Calculation of input signals.

SCOPE OF DELIVERY

Recorder, panel mounting bracket, accessories (ink cartridge (1), fuse (1), chart paper (1), input signal setting pin for replacement (1), ink absorption cloth (1)).
Instruction manual (1).

Note: Ink cartridge is not mounted on the recorder at the time of delivery.

Spare parts

Item	Part No.	Unit of quantity for sale
Ink cartridge	PHZH1002	1 pc
Chart paper (0 to 50, 50 uniform division)	PEX00DL1-5000B	1 box (6 charts)
Chart illumination lamp	PHZL1001	1 pc

Other (optional items)

Item	Type	Specification
Shunt resistor	PHZT1101	For 10Ω± 0.1 %
Alarm output/ external control unit	PHZK1601	With 6-point alarm output(N.O.)/ 3-point external control
	PHZK1611	With 6-point alarm output(N.C.)/ 3-point external control

The product conforms to the requirements of the Electromagnetic compatibility Directive 89/336/EEC as detailed within the technical construction file number TN510406. The applicables standards used to demonstrate compliance are:-

- EN 50081-1 :-1992 Conducted and Radiated emissions
- EN 50082-1 :-1992 Radiated immunity, ESD and FBT

OUTLINE DIAGRAMS (Unit:mm)

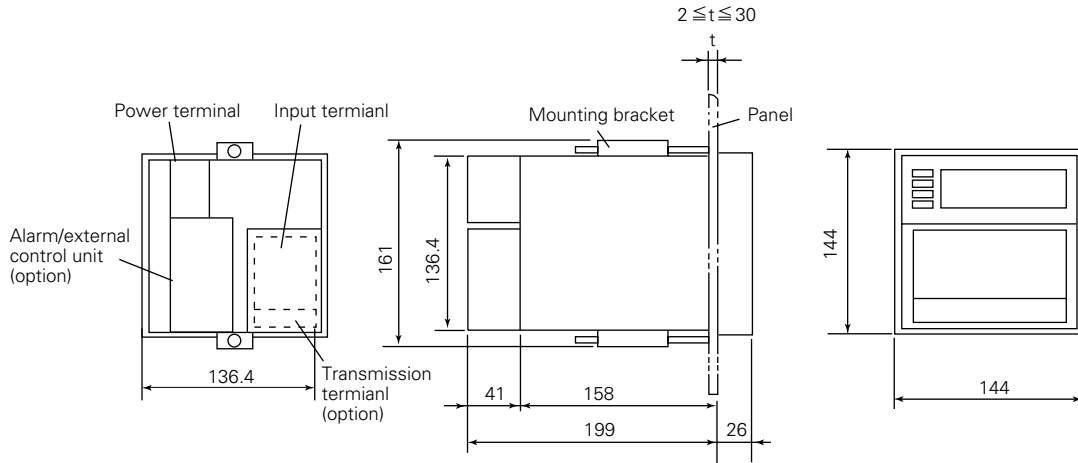

Panel cutout

When mounting one unit

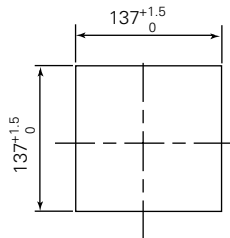

When mounting multiple unit

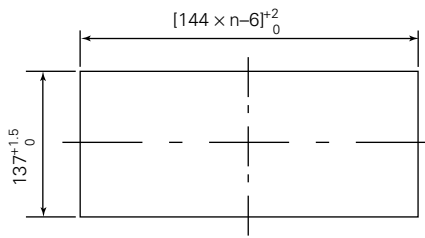

Note: When panel mounting, two brackets are necessary either on the top and bottom of the recorder.

CONNECTION DIAGRAMS

Input terminal

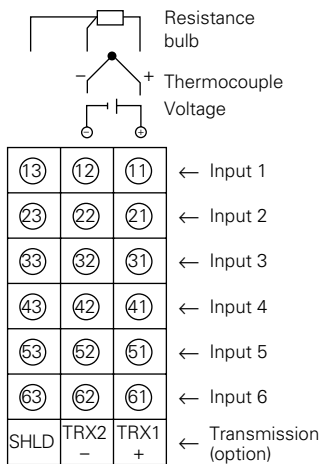

Alarm/external control unit (option)

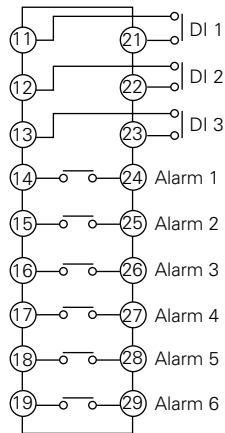

Power terminal

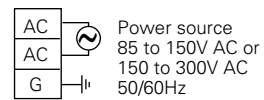

- DI 1 Record start or message print 1
- DI 2 Chart speed change or message point 2
- DI 3 Measured value printing or alarm latch cancel or message print 3

Note: Alarm relay contact is selectable N.O. or N.C. by Code Symbols.

Fuji Electric Co.,Ltd.

Head office

11-2, Osaki 1-chome, Shinagawa-ku, Tokyo, 141-0032 Japan
Phone: 81-3-5435-7111
<http://www.fujielectric.co.jp/eng/sg/KEISOKU/welcome.htm>

Fuji Electric Instruments Co.,Ltd.

Sales Div.

International Sales Dept.

No.1, Fuji-machi, Hino-city, Tokyo, 191-8502 Japan
Phone: 81-42-585-6201, 6202
Fax: 81-42-585-6187, 6189